

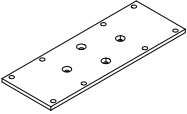
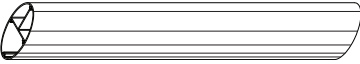
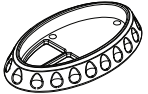
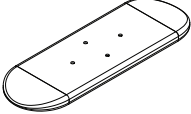
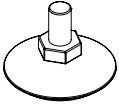
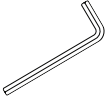
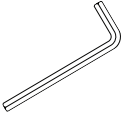
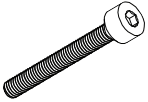

ULTIMATE SUPPORT®

Instructions for Assembling Side Leg

Included Parts with the Side Leg Assembly - BOX 8

	Side Leg Top Mounting Plate	x1
	Side Aluminum Leg Column	x1
	Mast Coupler	x1
	Side Aluminum Leg Base	x1
	Leg Leveler	x2
	M4 Hex Wrench	x1
	M5 Hex Wrench	x1
	M6 X 1 Socket Head Cap Screw	x4
	M6 X 1 Flat Head Screw	x4
	1/4 - 20 x 5/8" Pan Head Screw	x8

ULTIMATE S U P P O R T

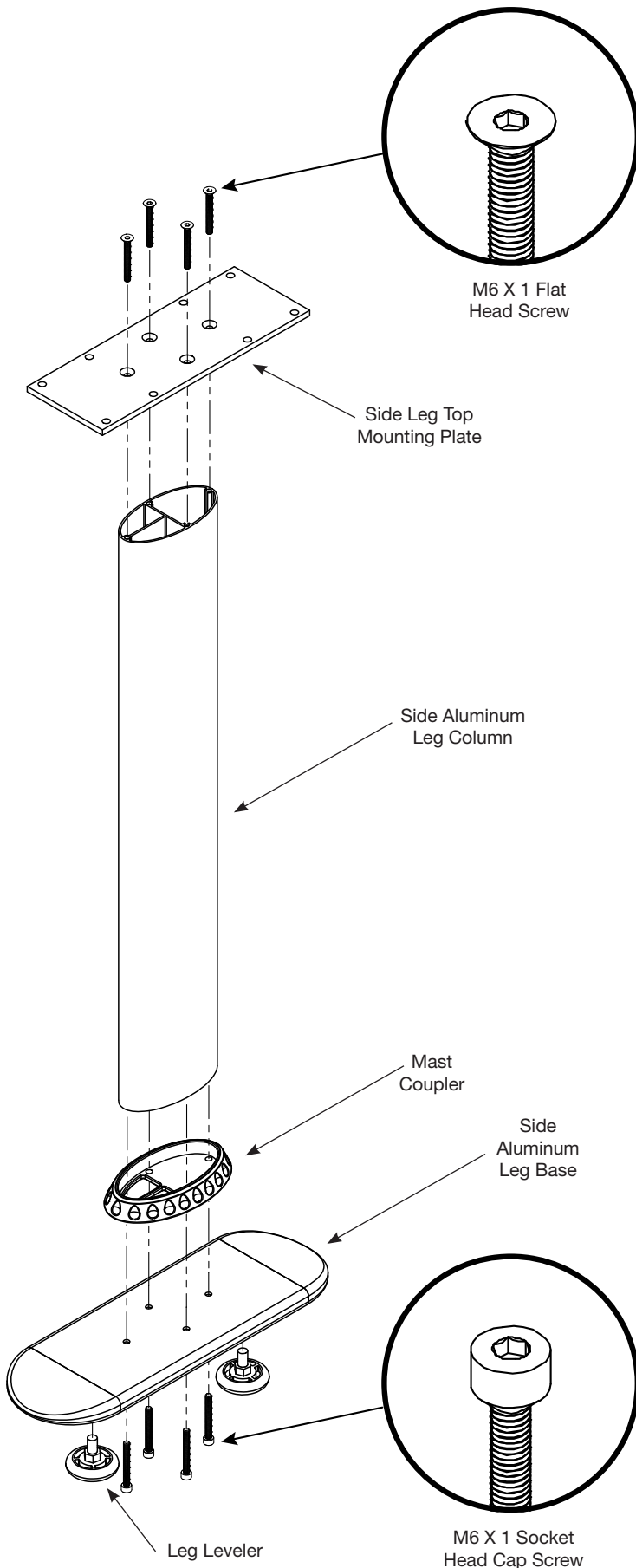

Place side leg top mounting plate on aluminum leg base, lining up the holes. Use the four flat head screws provided to attach plate to leg base. Use M4 hex wrench to tighten flat head screws.

On the opposite end of the aluminum leg base, slide on mast coupler.

On the bottom end with the mast coupler, attach side aluminum leg base using four socket head cap screws. Screws will go through the aluminum leg base, mast coupler and into the side aluminum leg base. Use M5 hex wrench to tighten socket head cap screws.

Screw the two leg levelers into the side aluminum leg base.

The additional eight pan head screws (1/4 - 20 x 5/8") are used for attaching the side leg to the 24" Extension Table Top. Set aside and save for later.